



UNIVERSAL TRAILERS | BOAT TRAILERS | CAR TRAILERS

---

## USER MANUAL

SIDEBOARD TRAILERS, PLATFORM TRAILERS, BOAT TRAILERS  
AND TRAILERS FOR MACHINES TRANSPORTATION

---

*Lorries - no worries!*



[www.lorries.co](http://www.lorries.co)

A decorative graphic at the bottom of the page consisting of a series of black and white chevron shapes pointing to the right, arranged in a row.

# Thank you for choosing a trailer for years!

The Lorries brand guarantees that you have just purchased a product created with practical needs in mind.

When designing your trailer, we thought about its capabilities and your comfort of use. Expert knowledge of our designers allowed us to design products based on current trends and modern materials and technologies.

Our many years of experience in the metal industry and the use of a modern machine park guarantee the highest quality and repeatability.

We are sure that Lorries trailer will be a perfect companion of your tasks or passions!

We reserve the right to make any constructional and technological changes that improve the quality and aesthetics of the product, but do not affect the interchangeability of parts and the operation of mechanisms. Such changes may not be included in the operating instructions. Therefore, there may be small deviations from the dimensions and weights given in the instructions.

Any comments and suggestions regarding this user manual please send to the following e-mail address:

[info@lorries.co](mailto:info@lorries.co) or [marketing@lorries.co](mailto:marketing@lorries.co)

## ATTENTION!

Together with the purchased trailer, you should receive:

1. Certificate of approval (required for first registration)
2. Manufacturer's declaration with data for registration purposes (required for registration in Poland)
3. VAT invoice
4. Warranty Card
5. User Instruction (paper or electronic version)

**LORRIES** by  **STALKO**

# TABLE OF CONTENTS

General safety rules .....	str. 4
Summarized version of the guarantee .....	str. 5

## CHAPTER I - Operation of trailers

I.I Identification data .....	str. 6
I.II Types and construction of trailers .....	str. 6
I.II.I Sideboard trailers - PB .....	str. 6
I.II.II Platform trailers - PL .....	str. 7
I.II.III Boat trailers - PP .....	str. 8
I.II.IV Trailers for machines transportation - TPM .....	str. 9
I.III Attaching / detaching a trailer to the vehicle .....	str. 10
I.IV Checking the position of the ball coupling .....	str. 11
I.V Loading and unloading the trailer .....	str. 12

## CHAPTER II - Service, maintenance and storage of trailers

II.I Maintenance of trailers .....	str. 13
II.II Cleaning of trailer and maintenance of the zinc plated parts .....	str. 13
II.III Storage of trailer .....	str. 14
II.IV Correct tire pressure .....	str. 14
II.V Electric installation .....	str. 14
II.VI Adjustment and maintenance of the trailer braking system .....	str. 15
II.VII Suspension and wheel bearings .....	str. 16
II.VIII Table of servicing activities .....	str. 17

## CHAPTER III - User instructions

III.I Problems and solutions .....	str. 18
III.II Disposal of the trailer .....	str. 19

## GENERAL SAFETY RULES

Before using the trailer:

1. read the operating manual and the WARRANTY BOOK,
2. the use and operation of the trailer may be performed **ONLY** by persons authorized to drive a vehicle with a trailer,
3. it is forbidden to use the trailer contrary to its purpose. Anyone who uses the trailer in a manner contrary to the purpose, in this way takes full responsibility for all consequences arising from such use,
4. check in the vehicle registration certificate that the particular trailer model can be connected to the vehicle (O1 position for braked trailers, or O2 for unbraked trailers)
5. pay attention to the ball hook wear (diameter of the ball must not be lower than 50mm)
6. follow the traffic rules for moving the set: car + trailer
7. make sure that the trailer is correctly attached to the car's hook
8. make sure that the trailer lights are working properly
9. make sure that the load on the trailer is evenly distributed and properly secured
10. when parking the trailer, secure it against rolling away using the wedges\*, and in the case of the trailer with brake **ADDITIONALLY** apply the parking brake.

When operating the trailer, remember that:

1. the car + trailer combination will behave differently under certain conditions than the car itself,
2. reaching the same speed will take longer,
3. the braking distance will be extended,
4. be careful when going down, especially on wet surfaces,
5. be careful when driving on sharp turns and reduce the speed,
6. always follow the road traffic regulations,
7. do not travel with a negative vertical load,
8. vertical loads shall be applied within acceptable limits,
9. observe the permissible static vertical load and permissible total weight of all assembled components,
10. for loading notes, see section I.V

### **ATTENTION!**

**REGISTERED TRAILER CAN ONLY BE COUPLED WITH A VEHICLE THAT IS APPROVED FOR A TOW BAR!  
TRAILERS CAN NOT BE USED FOR TRANSPORTATION OF PEOPLE.**

\*wedges, depending on the trailer model, are available as standard or option

## SUMMARIZED VERSION OF THE GUARANTEE

1. The guarantee is valid for a period of 24 months from the date of purchase of the product by a natural person for purposes that are not related to the economic activity of the person (User). If the product is purchased by the entrepreneur (User), the warranty is valid for a period of 12 months from the date of purchase.
2. The condition for maintaining the rights resulting from the guarantee is to periodically carry out maintenance and servicing of the trailer according to the attached operating instructions, and in the case of braked trailers, additional periodic inspections in accordance with the inspection card placed at the end of the guarantee card.
3. In the case of a product defect, the USER must notify the authorized representative within 3 working days from the date of this finding. The trailer should not be used until the defect is removed. MANUFACTURER or an authorized representative will provide instructions for further actions.
4. Normal use and wear of parts (e.g. brake blocks, tires and bulbs) are not covered by the warranty. The costs of delivering the product for warranty repairs and the costs of receiving the product after warranty repair from the service indicated by the MANUFACTURER are borne by the USER and they are not recoverable.
5. The warranty covers only the product of the MANUFACTURER, i.e. the trailer (structural elements, chassis, body, wheels and steering system, installations), with the exception of elements of equipment made by hand or on behalf of the USER with other entities.
6. The guarantee does not cover:
  - any defects and damages disclosed or reported after the end of the warranty period;
  - natural wear of parts such as: brake linings and their components, brake cables and their components, tire treads, bulbs, etc.;
  - defects and damages resulting from the impact of natural forces such as hail, lightning, frost, water, salt, chemical substances, UV radiation, etc.;
  - operating sub-assemblies and elements of equipment covered by a separate guarantee, such as: electric winch, hydraulic pump, etc.
  - damage to the subject of the guarantee resulting from conduct incompatible with the operating instructions, in particular resulted from improper operation, maintenance, operation, storage, use of improper consumables,
  - defects and damages resulting from the change of the original form or function of the product, including product malfunction due to a conflict between selfassembled components or parts;
  - defects and damages caused during the transport of the product, caused by improper assembly and protection of the product during transport;
  - damage resulting from the random incidents (electrical damage, fire, flood, collisions and traffic accidents, etc.),
  - damages resulting from the way the device is operated in conditions or in a manner inconsistent with the MANUFACTURER'S specification or user's manual;
  - maintenance activities described in the user manual, which the USER is obliged to perform at his own expense.

# I - OPERATION OF TRAILER

## I.I Identification data - markings on the trailer

Each trailer has a Certificate of Approval and a nameplate with a permanently stamped identification number (VIN). The nameplate is placed on the frame side member or on the draw-bar at the front of the trailer, depending on the model. In the event of damage or loss of the nameplate, please contact our service department immediately in order to issue a new nameplate.

The nameplate includes:

- approval number (1)
- identification number VIN (2)
- allowable total weight MC (3)
- maximum vertical load of the draw-bar (4)



## I.II Types and construction of trailers

### I.II.I Sideboard trailers - PB

Our offer includes standard sideboard trailers as well as sideboard tipping trailers, ideal for transporting loose materials. PB27-4320 and PUH10-2613 models are equipped with the overrunning brake. All other models have unbraked axis. Additionally, PB75-2613 and PB75-2614 models are available in double-axis version.

All trailers can work with the following vehicles:

- vehicle equipped with the tow ball hook,
- vehicles equipped with 13- or 7-pin electrical socket 12V, adapter is needed in case of 7-pin socket



1 - ball coupler, 2 - safety cable, 3 - hand brake, 4 - supporting wheel, 5 - frame, 6 - sides, 7 - marker lamp, 8 - mudguard, 9 - wheel, 10 - composite lamp, 11 - cargo holders, 12 - reflector, 13 - tipping box fastener (applies to trailers from PU series)



In addition to sideboard trailers, we offer various installation options: flat cover (PP), tarpaulin frame (PS), perforated top (NP), full flat top board (NBP) and front rail (RP). Ask dealer for details.



### I.II.II Platform trailers - (PL/ PLI)

Our offer includes also two series of platform trailers, these are: platform trailers equipped with steel ramps (PL series) and platform transporters with integrated ramps (PLI series). All platform trailers are available in two-axle version and are equipped with the parking brake as well as an overrunning brake, support wheel, spare wheel and manual winch up to 1135 kg.



In the case of standard PL and PLI trailers, due to the high intensity of use, inspections **are required every 10,000 km, but at least every 3 months.**

**It is extremely important to evenly distribute the weight of the load on the platform,** so that the load on the ball of the tow ball is between 50 and 100kg. Driving a car too close to the front edge of the trailer may result in too strong pressure on the ball of the tow hook. The transported car must be properly secured against movements, and in additionally, the wheels should be locked using the wedges (sold separately).



### **ATTENTION!**

**During transportation and moving with the carriage, both fasteners blocking the platform in the transport position must be ABSOLUTELY closed and secured with a cotter pin.**

### I.II.III Boat trailers and trailers for water scooters transport - PP

We produce also trailers for water scooters transportation as well as for boats and yachts. As standard, the series of PP trailers uses the **WPS system (Waterproof System)** - an additional hub seal that protects the hub bearings against water ingress. This system significantly extends the life of bearings, hubs and complete axles. The trailers are also equipped with a tilting lamp system, protecting the lamps from getting wet and a system of lengthening the rear lamps, thanks to which we can extend the trailer by an additional 1.1 m (does not apply to PP75-4011 and PP13-4021 models).



#### GENERAL RULES REGARDING USAGE OF THE BOAT TRAILERS:

- it is recommended to fit the edge of the boat and trailer before the first use,
- do not exceed the permissible trailer load (take into account the weight of the equipment, engine, gasoline and add up with the boat's own weight),
- the total length of the combination (car + trailer) can not exceed 18.75 m!
- the yacht's hull should be positioned in the such way that the trailer coupler loads the hook on the car. The pressure on the hook should not exceed 50kg.
- the boat must rest on the bottom rollers and be supported by roller supports or runners,
- during the transport, the boat must be secured with straps attached to the transport holders on the trailer (so-called shackles),
- you must obey the provisions of the road law regarding the dimensions of the load (in Poland without a permit you can drive a car with the trailer, whose width does not exceed 3m and can not protrude from the rear of the vehicle over a distance of more than 2m).
- before loading, check trailer lighting and tire pressure,
- it is important that the boat / scooter is located in the axis of the trailer.

#### CORRECT POSITIONING OF THE BOAT ON A TRAILER:

- rear side supports are mounted at the rear of the frame,
- keel of the boat should be supported on keel rolls (the whole weight), and the rollers / side supports should be moved so that there is no play,
- the bow of the boat should be placed on the stem.



## ATTENTION!

The weight on the hook should be proportionally distributed so that the trailer does not overturn.

All our trailers from the PP series, to allow the maximum adjustment of the rollers / skids to the shape and correct mounting of your boat enable:

- adjusting the position of the up-down and left-right rollers,
- regulation of the top-bottom and right-left skids,
- adjustment of the bottom rollers,
- adjustment of the belt winch position on the draw-bar,
- regulation of the height and tilting angle of the bow.

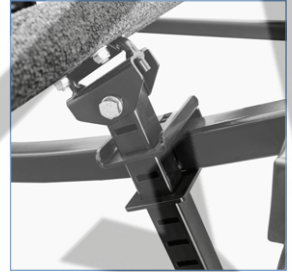

## LAUNCHING

During the launching, the trailer should be immersed only up to the height of the rims. It is not recommended to immerse brakes, cables, etc. Lamps should be open and raised when launching. If water gets into the brakes, frequent service inspections are necessary. Salt water causes corrosion. The braked trailers can be optionally equipped with a drum rinsing system.

I.II.IV Trailers for machines transportation - TPM

**It is extremely important to evenly distribute the weight of the load on the platform,** so that the load on the ball of the tow ball is between 50 and 100kg. Loading the trailer too close to the front edge of the trailer may result in too strong pressure on the ball of the tow hook. The transported machine must be properly secured against any movements.

## !ATTENTION!

**When transporting and moving with a TPM trailer  
- it is IMPERATIVE to block the ramp lock.**

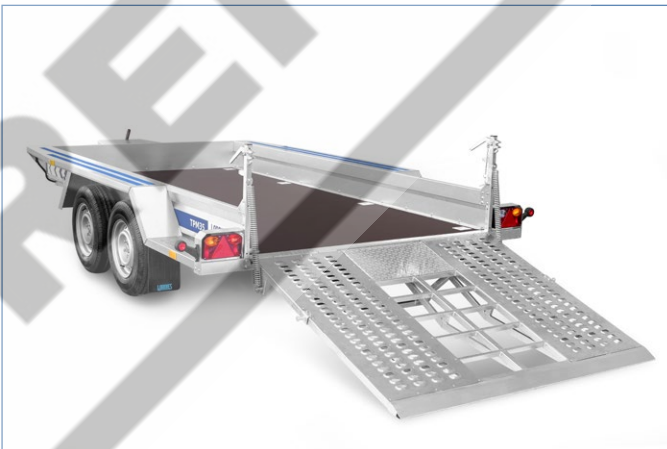

### I.III Attaching / detaching a trailer to / from the vehicle

#### Attaching the trailer:

1. Pull up the trailer to the position where the coupler is located above the ball of the vehicle's hook. Open the coupling head. The coupler must be in the opened position - X.
2. Lower the ball of the hook. The coupler will be closed on the ball and you will hear a click. The indicator will be in the green „+” position.
3. In order to check that the tow-bar is secure, check the position of the indicator (KNOTT coupler) and the clearance between the hook and the ball.

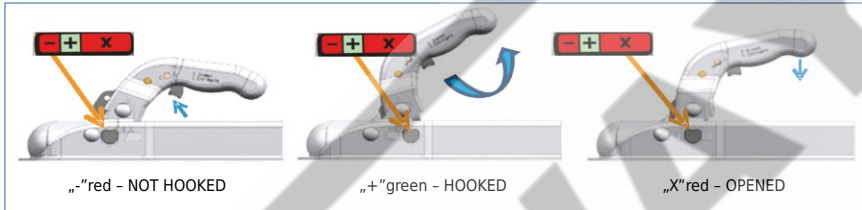

4. If the indicator is in the red position „-” when fastened to the vehicle's hook, it means that the vehicle and the trailer are not connected correctly and it is NOT allowed to drive with the trailer. The cause of this situation may be the wear of the hook or the ball of the hook.
5. Pull the hook a few times upwards to make sure it is properly hooked.
6. Install a safety rope on the coupler of the tow hook:
  - UNBRAKED TRAILERS - so as to protect the ball coupling against contact with the ground in the event of a release;
  - BRAKED TRAILERS - so that if the ball hitch goes out, the brakes of the trailer is applied;
7. Connect the trailer's electrical installation to the car's electrical installation by inserting the plug from the trailer into the socket on the towing hook.
8. Check proper operation of the lights.
9. The support wheel should be raised as much as possible and locked. Secure against loss and possible looseness. The support wheel should be parallel to the direction of travel. Make sure that the rope is not wrapped around the support wheel.
10. When detaching the coupler from the ball: press the tab and pull the handle upright. The coupler will be unhooked and will open automatically. The indicator should be in the red „X” position. Then lower the support wheel down so that the disconnection takes place. Remove the plug from the socket and remove the safety rope.

#### **!ATTENTION!**

**DRIVING WITH A TRAILER WITH THE INDICATOR IN „X” POSITION IS NOT ALLOWED!**

#### I. IV Checking the position of the ball coupler

The ball coupling can be rotated up to  $\pm 25^\circ$  to the longitudinal axis of the vehicle. It is also possible to turn maximum  $\pm 20^\circ$  along the horizontal plane.

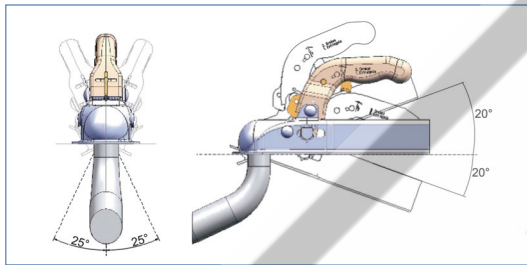

The ball coupling can be secured in both unhooked and hooked positions.

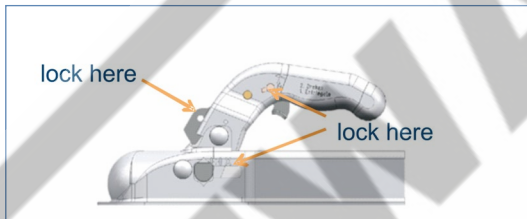

The coupling height of the towing vehicle and trailer depends on:

- the pressure in the vehicle and trailer tires recommended by the manufacturer
- the load on the trailer - it should not exceed the maximum value and should be evenly distributed
- the trailer is properly connected to the towing vehicle

On a flat surface, without any inclinations, the height of the vehicle coupling and trailer should coincide, and its axis should be at a height of 350-420 mm from the ground when the car is loaded to the PTW (permissible total weight).

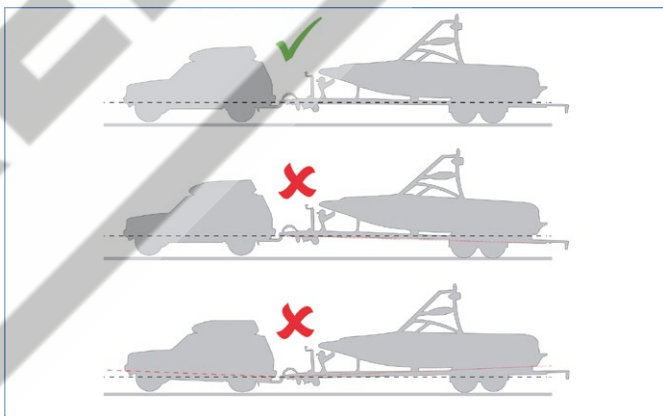

## I.V Loading and unloading the trailer

- The nameplate and registration document indicate the gross weight of the trailer.
- The trailer is designed in such way that the center of gravity is just in front of the axle.
- The load must be distributed evenly as close as possible to the front, taking into account the maximum permissible vertical load of the draw-bar S - stamped on the body of the coupling head.



- The load must be secured against displacement.
- The load should be placed in such way that it does not exert significant pressure on the side walls, because it may cause bending of the sides and damage to the load.
- The correct pressure on the ball of the towing hook is very important for stability. This pressure should be at least 4% of the total actual trailer weight, or minimum of 25kg.
- Do not exceed the maximum permitted load on the ball hook for your car and trailer. The load on the ball of the towing hook is a force called the **support load**.
- **Too small support load** usually appears when the trailer has a heavier back. It can then occur:
  - lack of stability of the vehicles combination,
  - vibrations or dislocations of the vehicles combination,
  - extended braking distance,
  - tilt the vehicle headlights down and shorten the range of lights,
  - dislocating the trailer,
- **Too large supporting load**, i.e. a situation when the trailer has a heavier front, may cause:
  - tilting the headlamps up, causing the drivers driving from the opposite direction to dazzle
  - difficulty in controlling the vehicle,
  - reduced grip in case of cars with front-wheel drive,
- Unloading and loading of the trailer should take place only when the vehicle is placed on a horizontal hard surface, and the whole combination (car and trailer) is set for straight-ahead driving.
- In winter, pay special attention to snow and ice that can be on the tarpaulin of the trailer. If necessary, remove it.

## II - INSPECTIONS AND MAINTENANCE OF THE TRAILER

### II.I Trailer maintenance

- All fastening elements should be checked and tightened for the first time after 500 km, and then after 1000 km and then every 5000 km (this does not apply to the mounting bolt on the wheel hub).
- The bolts fixing the wheels should be tightened after 50km of the drive, and then every 5000km and after each replacement of the wheel or tire. The screws should be tightened diagonally with a torque wrench (steel rims - 90Nm, aluminium - 100Nm).
- Before each trip of a trailer with a tilting box, check that the lock that fastens the draw-bar and the body is properly fastened and that a safety device is fitted. This applies to the following tipping trailers: PU75-2012, PU75-2613 and PUH10-2613
- Regularly check the condition of the ball of the car's hook, its diameter should be 50mm +/-5mm.
- If there is a clearance between the ball and the coupling head, the symptom during operation may be, for example, knocking, the ball or towing eye is worn and the worn part must be replaced with a new one.
- It is NOT ALLOWED to make any changes to the coupling head.
- Regularly check the presence of the grease at the place where the hook is attached to the ball of the hook and fill up if necessary. This operation should be performed depending on the operation, not less than every 1000 km.
- The overrun device must be greased every 3000 km.

### II.II Cleaning of the trailer and maintenance of the zinc plated parts

The frames and draw-bars of all our trailers are subjected to a hot-dip galvanizing process. In turn, the sideboards and extensions are made of electrolytically galvanized sheet.

The zinc coating is resistant to mechanical damage (e.g. impacts). It is also the only anti-corrosion coating that does not lose its properties in case of local damage; it is possible thanks to the so-called electrochemical protection.

Over time, the zinc coating changes its appearance from shiny to grey and matte. This happens as a result of the reaction that takes place between zinc and air. The influence of water leads to the formation of zinc hydroxide. Then it turns into patina, which binds to the substrate and does not let water through.

When a patina is formed in a proper way, it will stop the occurrence of subsequent chemical reactions. Thus, it effectively protects against corrosion. Patina is formed on average from three months to even two years. The time depends on the conditions for the zinc.

Moisture may cause white spots on the surface. It is the so-called zinc hydroxide, white corrosion, which does not deteriorate the quality of the protective layer and can not be the cause of the complaint.

### **ATTENTION!**

**GALVANIZED ELEMENTS SHOULD BE FREQUENTLY WASHED AND AFTER CONTACT WITH ROAD SALT, SEA SALT OR CHEMICALS EVERY TIME!**

### II.III Storage of trailer

It is recommended that the trailer during storage should be protected against weather conditions, especially those that cause corrosion and accelerate the aging of tires or the load on the tarpaulin frame (rain, snow, sun).

### II.IV Correct tire pressure

Different types of tires require different pressures at different loads. Therefore, in order for the tires to function properly and not wear out too quickly, please follow the tire pressures recommended by the manufacturer. The maximum values are always placed on the tire. Examples of markings are showed on the pictures below.



### II.V Electric installation

All our trailers, as standard, are equipped with 13-pin plugs (designed for trailers with their own reversing light) and are designed for 12V voltage.

If the trailer is connected to a 7-pin socket, use the appropriate adapter / adapter. **However, remember that in this case, when reversing the reversing light will not work!**

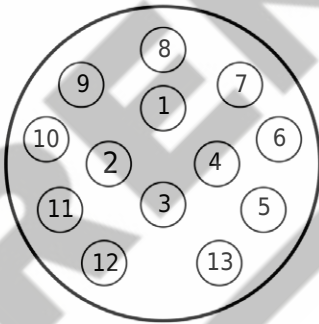

NO	CABLE COLOR	CONNECTION
1	Yellow	Left turn signal
2	Blue	anti-fog lights
3	White	Mass for 1...8 pins
4	Green	right turn signal
5	Brown	Right position light
6	Red	braking light (stop)
7	Black	Left position light + registration plate
8	Grey	back-up light
9	brown-blue	spare
10		spare
11		spare
12		spare
13		spare

View of the pins in 13-pin plug

## II.VI Adjustment and maintenance of the trailer braking system

Trailers with brakes are equipped with overrun devices that use the inertia of the trailer during braking. During braking, the trailer exerts pressure on the overrun device, which by means of the transmission system (brake rod, rudder bar and brake lines) causes the operation of the trailer axle brake. The overrun mechanism is constructed in such a way that it allows reversing with the trailer without additional activities. When switching from reverse to forward ride, the braking system is automatically ready for operation.

In addition, the braked trailers have a parking brake system which is activated by means of the hand lever located at the overrun device. It ensures braking of the trailer on falls up to 16%

Pushing and releasing the parking brake (manual) is done by vigorously pulling / releasing the brake lever (figure below).

### **ATTENTION!**

**IT IS RECOMMENDED THAT IN THE EVENT OF A LONGER STOPPAGE ON A SLOPE, APPLY THE HANDBRAKE AND ADDITIONALLY PLACE WEDGES UNDER THE WHEELS.**

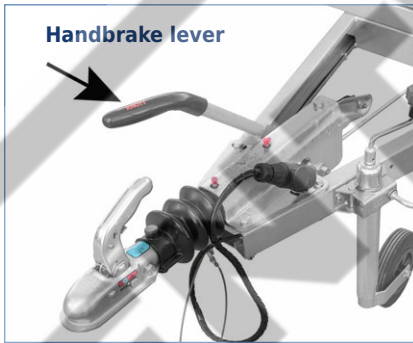

The trailer braking system requires maintenance and adjustments on the site. When using the trailer, regularly pay attention to the depth of insertion of the tow-bar. If it is necessary to press the coupler over 45-50mm to obtain braking, it must be repaired by a professional. You should also regularly check the wear of the brake shoes.

**WE ARE RECOMMENDED TO MAKE ADJUSTMENTS AND REPAIRS OF BRAKES ON THE SERVICE ONLY BY AUTHORIZED SPECIALISTS.**

The overrun device, to facilitate refilling or replacement of the lubricant, is equipped with so-called grease nipples, thanks to which this operation can be easily performed using a manual or pneumatic grease gun. A special lithium grease for bearings, e.g. SPHEEROL EPL2, is recommended for maintenance of the overrun device.

## Adjustment of the braking system:

1. To adjust the braking system, lift the trailer up from the adjustment side.
2. Remove the wheel on the side where we adjust the brakes so that the drum can be rotated freely.
3. Adjustment is carried out using the adjusting screw (1) of the expansion cube, which is located on the inside of the plunger.
4. The adjustment consists in loosening and tightening the adjusting screw until the brake shoes start to rub against the drum and the wheel can be rotated with a noticeable resistance.
5. Then, slightly loosen the screw so that the wheel turns easily and the jaws lightly rub against the drum.
6. Repeat this operation separately for all trailer wheels that are braked.
7. If after adjusting the brake rod is not tight, it must be tensioned using the ball nut and counter nut.

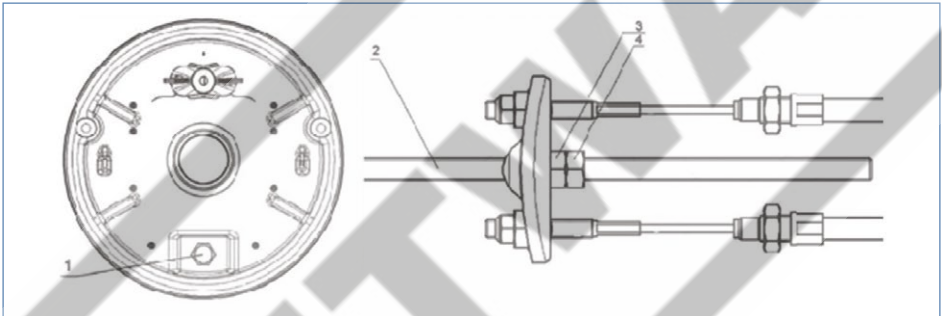

SOURCE KNOTT SP. Z O.O.

## II.VII Suspension and wheel bearings

Trailers of the LORRIES brand are equipped with maintenance-free bearings, factory-supplied with an appropriate amount of grease by the manufacturer. Therefore, it is not necessary to check the amount of grease in the bearings

If the bearing is damaged, the entire brake drum must be replaced, as the bearing is an integral part of the brake drum and cannot be changed by the user.

### **ATTENTION!**

**WHEN REPLACING THE BRAKE DRUM, USE ONLY A NEW AND ORIGINAL NUT. THIS NUT SHOULD BE TIGHTENED USING THE TORQUE WRENCH RECOMMENDED BY THE MANUFACTURER.**



## II.VIII Table of servicing activities

PERIOD	TYPE OF ACTIVITY
<i>Regularly</i>	<ul style="list-style-type: none"> <li>• Keeping the trailer clean</li> <li>• Taking care for the tow bar to be clean and lubricated</li> <li>• CLEANING THE TRAILER AFTER EACH contact of the trailer with salt road and sea water</li> <li>• Checking the correct tire pressure</li> <li>• Check the lighting in the trailer (direction indicators, position and side marker lights, STOP light)</li> <li>• Check the condition of the sideboards and fastenings,</li> </ul>
<i>After one month or 500km</i>	<ul style="list-style-type: none"> <li>• Inspection of the wheel bearing adjustment</li> <li>• Condition of the ball coupling</li> <li>• Inspection of the braking system</li> <li>• check and tighten all fasteners</li> </ul>
<i>After 6 months or 1,000km</i>	<ul style="list-style-type: none"> <li>• Inspection of the braking system</li> <li>• Brakes adjustment</li> <li>• Checking the adjustment of bearings</li> <li>• Lubrication of the bearing bushings for the overrun device</li> <li>• Tires usage</li> <li>• check and tighten all fasteners</li> </ul>
<i>After 12 months or 5,000km</i>	<ul style="list-style-type: none"> <li>• Inspection of the braking system</li> <li>• Ropes maintenance</li> <li>• Inspection of the overrun device</li> <li>• Inspection of the bearings adjustment</li> <li>• Condition of the ball coupling</li> <li>• Tires usage</li> <li>• Inspection of the wheel alignment</li> </ul>
<i>Every 12 months or 10,000-15,000km</i>	<ul style="list-style-type: none"> <li>• Inspection and adjustment of the braking system,</li> <li>• Inspection and maintenance of the overrun device,</li> <li>• Tires condition,</li> <li>• Bearings adjustment,</li> <li>• Check cables and cable fastening</li> <li>• maintenance of the sideboards and ramps hinges and fastenings</li> <li>• Inspection of the ball coupler condition,</li> <li>• check and tighten all fasteners</li> </ul>

## CHAPTER III - User instructions

### III.I Problems and solutions

Below we described typical faults and what should be checked and how to solve the problem.

PROBLEM	CAUSE	SOLUTION
<b>BRAKING SYSTEM</b>		
The trailer jerks when braking. The trailer brakes during the reduction of gears in the car.	The shock absorber in the overrun device is damaged.	Replace the shock absorber.
The trailer brakes as soon as the accelerator pedal is released	The shock absorber in the overrun device is damaged. The brake cables are too tight.	Replace the shock absorber. Loosen the brake cables.
The trailer clanks	The ball coupling or ball of the towing hook is worn out.	Check the cause of the play. Replace the tow hook or tow-bar.
Undoing with a trailer is difficult or impossible	The brakes are too tight. The brake cables are stretched.	Adjust the brakes.
The brakes overheat	<ul style="list-style-type: none"> <li>• Brakes are incorrectly adjusted</li> <li>• the brake hose is damaged</li> <li>• the return spring on the cladding is damaged</li> <li>• the handbrake has not been fully released</li> <li>• wear of trailer hub bearings</li> </ul>	Adjust the brakes. Check the brake cables. Check the hub bearings and replace, if necessary.
The trailer easily gets into the skid. The trailer tugs sideways.	Brakes are incorrectly adjusted.	Adjust the brakes and check that the brake hoses are not rusty.
The trailer brakes all the time.	Brake pads stuck to the drum after a long period of non-use	Free the cladding by gently striking the side of the anchor plate

PROBLEM	CAUSE	SOLUTION
Blocking wheels while driving	Opening of the brake shoes in the drums	SERIOUS FAILURE contact with the service - replacement of the jaws set
Uneven braking	Brake cables and brake cylinders are stuck	Replacement of cables and spreaders with new ones or their lubrication
The parking brake works too poorly	Incorrect brake setting. The parking brake lever is not tightened.	Set the brake correctly Tighten the handbrake lever
During braking you can hear disturbing noises: grinding, metal rubbing against metal	Brake lining wear on at least one jaw.	Replace the set of brake shoes on the axle
BALL COUPLER		
After mounting the towing ball on the ball, the catch does not latch	<ul style="list-style-type: none"> <li>• Too large diameter of the ball hook</li> <li>• Dirt and stopped internal parts of the hitch</li> </ul>	Replace the ball of the hook Clean and lubricate the hitch if necessary, replace the hitch with a new one
The trailer can not be detached from the hook	Mechanical damage to the ball-hook, irregularities on the ball	Position the trailer in one line and unhitch the trailer Replace the ball of the hook
There is a clearance between the hook and the ball	Worn coupler Worn tow-hook Too small diameter of the ball	Replace the ball of the tow-hook Replace the ball coupler

## ATTENTION!

**DAMAGE TO THE MECHANISM THAT DEACTIVATES THE OVERRUN BRAKE USUALLY ARISES WHEN DRIVING THE WHEEL (WHEELS) ONTO THE CURB WHEN REVERSING. AT THE SAME TIME, THE OVERRUN BRAKE SHOULD AUTOMATICALLY TURN OFF. IF THIS IS NOT THE CASE, LUBRICATE THE ROLLER CAM THAT DISENGAGES THE BRAKE AND THE CAM SURFACE INSIDE THE BRAKE.**

### III.II Disposal of the trailer

LORRIES trailers are products consisting of many materials. Some elements are made of plastic. When the trailer reaches the end of its life, the trailer should be taken to a company authorized to utilize the vehicles for recycling.

# RENTWAY

STALKO Spółka z ograniczoną odpowiedzialnością sp.k.  
(dawniej HITZE Sp. z o.o.)

ul. Solec 24/253, 00-403 Warszawa, POLAND

Headquarters:

ul. Gdyńska 32, 26-600 Radom, POLAND



+48 48 377 99 01



info@lorries.co

[www.lorries.co](http://www.lorries.co)